

**INTERPRETATIONS
OF THE
NATIONAL GRADING
RULE FOR
DIMENSION LUMBER**

SDL GLOSSARY

	Paragraph
GENERAL	1.0
BARK AND PITCH POCKETS	1.1
BEVEL SAWING	1.2
COMPRESSION WOOD AND TIMBER BREAKS ..	1.3
CELL COLLAPSE	1.4
CHECKS	1.5
CHIP AND SAW CHANNELS (Rabbeted Edge) . . .	1.6
COMPRESSION WOOD	1.7
HOLES	1.8
INSECT HOLES	1.8.1
MANUFACTURED HOLES	1.8.2
KNOTS	1.9
KNOT MEASUREMENT	1.9.1
KNOT LOCATION	1.9.2
KNOT SPACING	1.9.3
ASSESSMENT OF GRAIN DEVIATION AROUND KNOTS	1.9.4
PLANNER TEARS	1.10
ROLLER CHECKS	1.11
SAW CUTS (Saw Kerfs)	1.12
SHAKE	1.13
METHOD OF MEASURING SHAKE	1.13.1
SKIPS	1.14
SLOPE OF GRAIN	1.15
SPLITS	1.16
UN SOUND WOOD	1.17
WANE	1.18
WARP	1.19

1.0 GENERAL

The limiting provisions of the National Grading Rule delineate the characteristics permitted. However, because lumber is manufactured from trees which have developed naturally and responsively to their environment and every piece is different it is not possible to anticipate in a grade description all of the possible combinations or types of characteristics which a grader will encounter. These National Grading Rule Interpretations provide additional information to the grader/inspector in the application of the National Grading Rule. These interpretations have been approved by the National Grading Rule Committee and shall be considered a mandatory part of the National Grading Rule.

All measurements are based on actual size unless otherwise specified except splits and warp are based on nominal.

The limitations on knot sizes and other characteristics governing strength shall not be exceeded.

1.1 BARK AND PITCH POCKETS

Bark or pitch pockets are not restricted as to number.

1.2 BEVEL SAWING

Limited on the basis of equivalent loss of wood from wane.

1.3 BREAKS – TIMBER BREAKS AND COMPRESSION FAILURES -

Separations resulting from seasoning which occur in allowable bands of compression wood shall not be evaluated as timber breaks or compression failures.

Compression failures and timber breaks are permitted only in the grades of Standard, No. 3, Utility and Stud. They are limited to the size of the allowable knot hole and measured on the worst face.

1.4 CELL COLLAPSE - Cell collapse shall be evaluated as either wane or skip.

1.5 CHECKS - Seasoning checks extending from wide faces completely through the narrow face are limited as planer tears.

1.6 CHIP AND SAW CHANNELS (RABBETED EDGE) - Is limited on a basis of wane except in those instances in which the depth or width of the cut exceeds the full length wane provisions, the limitation shall be on a basis of equivalent loss of wood from maximum natural wane.

1.7 COMPRESSION WOOD - Compression wood shall be limited in effect to other appearance or strength-reducing characteristics permitted in the grade.

1.8 HOLES -

1.8.1 INSECT HOLES: Pin holes, grub holes and toredo holes are handled on an "equivalent smaller" basis. Equivalent smaller shall mean that the area occupied by all pin, grub and toredo holes shall be added together and treated as the maximum size hole permitted. For example, twelve 1/4" holes shall be accepted as equivalent to a single 1" hole. The poorest face shall govern.

1.8.2 MANUFACTURED HOLES: The area of a manufactured hole shall not exceed the equivalent area of the knot hole permitted and is limited to one manufactured hole in lengths of 12' or less of length, or two in lengths longer than 12'. The following length restrictions shall apply:

- SELECT STRUCTURAL - equal in length to diameter of hole permitted
- NO. 1 and CONSTRUCTION - equal in length to 1-1/2 times diameter of hole permitted.
- NO. 2 and STANDARD - equal in length to width of piece.
- NO. 3, UTILITY and STUD - equal in length to 1-1/2 times width of piece.

Manufactured holes are defects caused by the manufacturing process that are not specifically listed in the grading rule (e.g. Dog holes, log turner marks, debarker damage, etc.). The length of manufactured holes shall be the entire length of the defect encountered and limited to the frequency and length restrictions as listed. Manufactured holes that have no more effect on the grade of the piece than wane shall be assessed and limited as wane but not a combination of the wane and manufactured hole limitations. The listed limitations for manufactured holes shall not be used to exceed the maximum wane limitations of the grade.

1.9 KNOTS -

1.9.1 KNOT MEASUREMENT: Knots appearing on wide faces are measured between lines enclosing the knot drawn parallel to the edge (See Figure 1). Knot size is equal to the average of the two wide face measurements (See Figure 2).

Figure 1

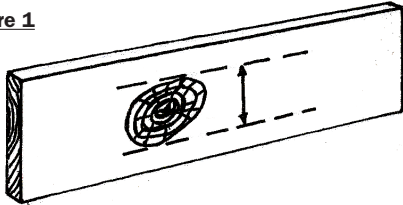

Figure 2



Except as otherwise provided, in these interpretations for knots on narrow faces, the cross sectional area displacement shall not exceed that of the maximum knot allowed at the edge of the wide face (see chart in Figure 3 for allowable displacement percentages).

Figure 3: Allowable Displacement of Narrow Face Knots (in percentage)

Nom Width	LIGHT FRAMING			STRUCTURAL LIGHT FRAMING				STRUCTURAL JOISTS & PLANKS			
	Const	Stand	Util	SS	No.1	No.2	Stud No.3	SS	No.1	No.2	No.3
2"	50	67	83	25	33	42	50				
3"	50	60	80	20	30	35	50				
4"	43	57	71	21	29	36	50				
5"								22	28	36	50
6"								20	27	34	50
8"								21	28	34	48
10"								20	27	35	49
12"								20	27	33	49
14"								18	24	31	45

Narrow face knots (spike knots) shall be measured according to the formulas depicted in Figure 4. The measurement of wide face knots overlapping one or two edges is demonstrated in Figure 5.

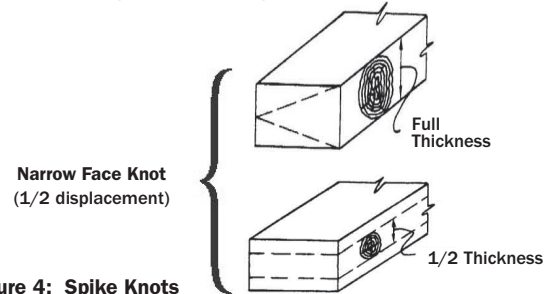
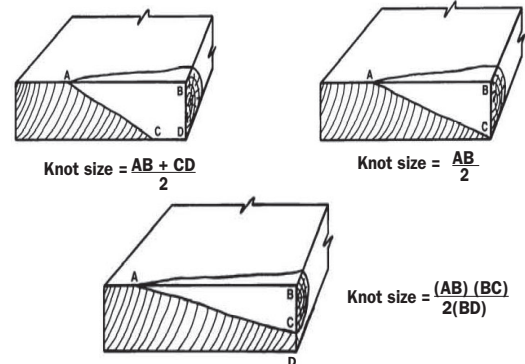
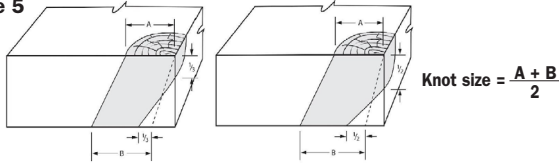

Figure 4: Spike Knots



3 Face Knots

Figure 5



4 Face Knot

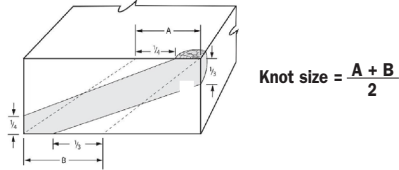

1.9.2 Knot Location

The allowable size for knots on wide faces, when appearing away from the edge, shall be proportionately increased from the size specified for knots located at the edge of the wide face to the size specified for knots located along the center line. The increase shall start at a distance from the edge equal to 1/2 the diameter of the allowable edge knot (Figure 6).

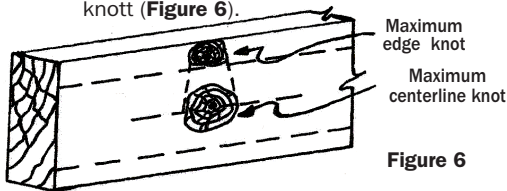

The size of knots on wide faces are permitted to be increased proportionately from the size permitted at the edge to the size permitted at the centerline.

Knots appearing on wide faces shall be considered as located at the **midpoint** of its displacement (Figure 7).

Figure 7

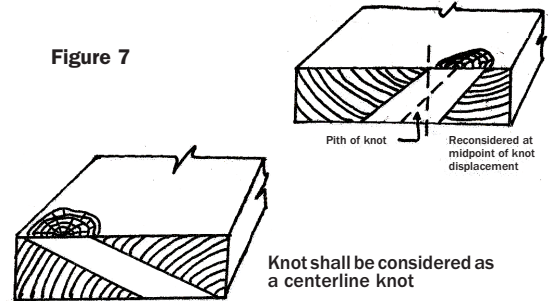

A wide face knot overlapping part of the edge shall be considered an **edge knot** if it occupies more than 1/2 the thickness (Figure 8).

Figure 8

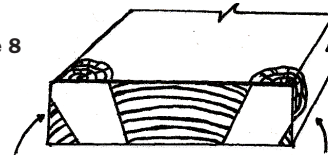

Knots overlapping less than 1/2 the narrow face shall be increased proportionately to centerline knot size.

Knots overlapping more than 1/2 the narrow face are considered edge knots.

The allowable size for diagonal knots that only involve the wide face shall be proportionately increased to the size specified for knots located along the center line. (See Figure 7 above). Diagonal knots involving both narrow faces are equated to an **edge knot** (See Figure 9).

Figure 9

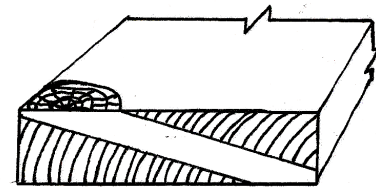

Knot located at edge of wide face

1.9.3 Knot Spacing

When two or more knots appear in the same cross section the sum of their sizes or displacement shall not exceed the maximum size specified for the center line knot (**See Figure 10**). When reference is made to knots in the same cross section, the cross section is the area across the width of a piece equal to the diameter of the largest knot present (**See Figure 11**). If loose knots, fixed knots or holes on the edge are involved, the sum of their sizes or displacement is limited to the maximum edge knot size. When directly opposite spike knots in boxed heart pieces are involved, the sum of their sizes or displacement shall not exceed the allowable centerline knot.

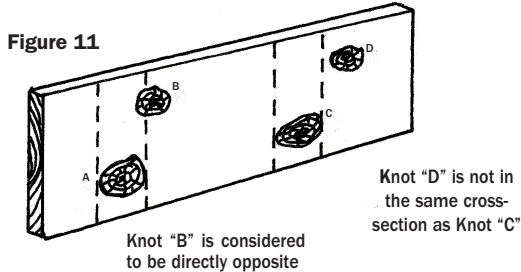
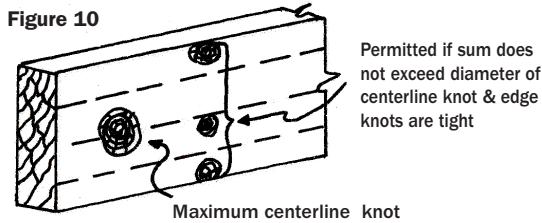

The sum of the sizes of all knots within any 6" of length shall not exceed twice the diameter of the allowable centerline knot (**See Figure 12**). No two centerline knots of maximum size shall appear in the same 6" of length.

Example for a Select Structural 2 X 8

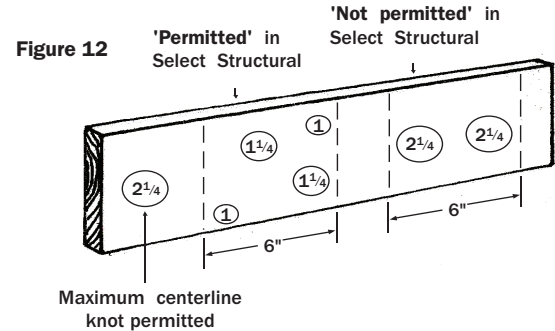

Two maximum edge knots appearing on opposite edges shall be spaced at least a lengthwise distance equal to **twice** the size of the allowable edge knot (**See Figure 13**).

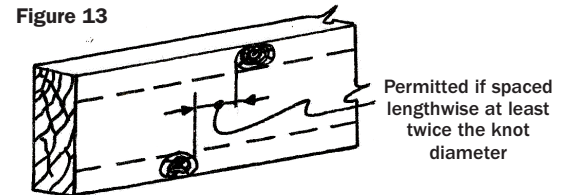

When the sum of knots at opposite edges on a wide face exceeds the allowable size of the centerline knot but either or both are less than the size allowed at edge of wide face, the lengthwise spacing shall be proportionate (**See Figure 14**).

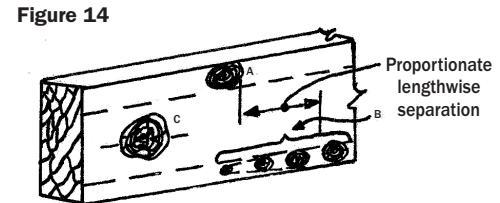

When "A" plus "B" exceeds the diameter of "C" but either or both are less than the maximum allowed, the lengthwise separation is proportionate

1.9.4 Assessment of Grain Deviations Around Knots:

Abnormal distortion is defined as grain deviation associated with a knot which is greater than that associated with a typical knot of the same size. When abnormal grain distortion is evident, the measurement of the knot size shall include the extent of distortion. The most critical influence of any grain deflection occurs on the narrow face or through the thickness of the piece. Abnormal grain distortion is characterized by a steep gradient running in the direction of the knot which produces extensive chipped or torn grain on the face in a semi-circular pattern around the knot.

1.10 PLANER TEARS

Planer or chipper tears are permitted in No. 2/Standard and higher grades provided they are not more than the width of the piece in length and not more than 1/4" in depth. In No. 3, Utility, and Stud grades, tears shall not exceed the allowable hole size in depth, nor the permissible split in length.

1.11 ROLLER CHECKS

If through at the end, treat equivalent to a split. When away from ends, treat as shake.

1.10 SAW CUTS (SAW KERFS)

This characteristic occurs in two ways: (1) the cut passes completely through the thickness and extends across a portion of the width (See Figure 15) and (2) the cut does not pass completely through the thickness and extends completely or partially across the width (See Figure 16).

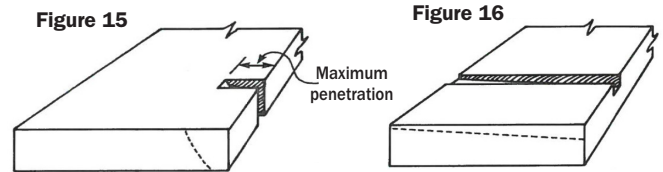

Figure 15 restricts the maximum penetration across the width to 1/2 the allowable edge knot size. The cut described in Item 2 above, as depicted by Figure 16 restricts the penetration to 1/2 the equivalent edge knot displacement.

Note: Generally no saw kerfs would be allowed in Select Structural and No. 1 grades.

1.13 SHAKE

A shake is "well separated" or "scattered" (i.e. not continuous) if there is evidence of wood separating the shakes. A surface shake is not permitted to extend into an adjacent or opposite face.

In No. 2 and Standard, shake through from one wide face to the other is not permitted to extend into the edge. A shake showing on only one wide face extending into one edge shall be limited to a depth of 3/4 the thickness and a length of 2'.

Shake extending from one wide face through the edge to the other wide face is permitted in No. 3, Utility and Stud and is measured from the point at which the shake enters the piece as illustrated (See Figure 17 and Figure 18). The shake shall not extend across the wide face more than the width of the allowable hole, measured on the worst face penetration. The shake is limited in length to 1/6 the length of the piece in No. 3 and Utility, and 1/3 the length of the piece in Stud grade.

Figure 17

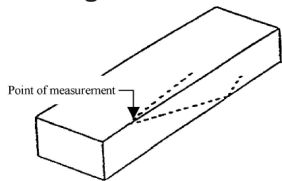
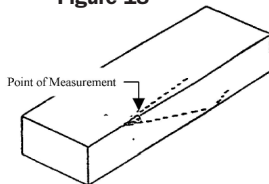

Figure 18



1.13.1 Method of Measuring Shake

Shake limitations are stated in the rule. Measure shakes parallel to wide face. (Figures 19-22)

Figure 19

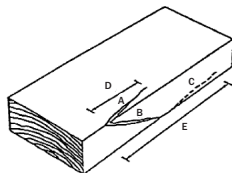

$$\frac{\text{Length D} + \text{Length E}}{2}$$

Figure 20

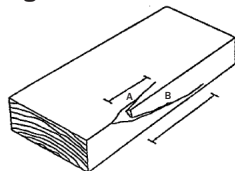

$$\frac{\text{Length A} + \text{Length B}}{2}$$

Figure 21

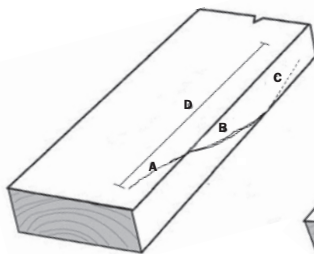

Measure Length D

Figure 22

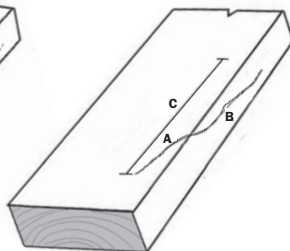

Measure Length C

1.14 SKIPS

"Hit & Miss" skip is defined as a series of skips not over 1/16" deep with surfaced areas between. Where this degree of skip is permitted, it shall be further clarified to include that the "hits" shall average one hit per four lineal feet of length. A "hit" is a plainly visible surfaced area approximately 1/2 the width or more and 2" or more in length. No piece shall have less than two hits.

Hit or Miss provisions shall not be used to permit surfacing below specified minimum sizes.

When skips appear on opposing faces the combined scantness shall not exceed the depth permitted.

In Select Structural, No. 1 and Construction, one medium skip 2' in length is not to be included in the limitation of "10% hit and miss."

In No. 2, Standard, No. 3 and Utility, the maximum skip must never appear on both the wide face and narrow face in the same cross section (in No.2, Standard-does not apply to hit or miss skip).

Skips permitted on the surfaced face of resawn Stress Rated Boards is limited according to the rules under which it is graded, independent of the variation in thickness permitted in resawn boards.

1.15 SLOPE OF GRAIN

Slope of Grain on Narrow Faces and Local Deviations:

In 1" stress-rated boards or similar small sizes of stress-rated lumber, a general slope of grain anywhere in the length shall not pass completely through the thickness of the piece in a longitudinal distance in inches less than the number expressing the specified permissible slope. Where such a slope varies across the width of the board, its average shall be taken, except when the slope of grain occurs in a way that effects the piece more than other permitted strength reducing grade characteristics. Slope of grain on narrow faces of 2" in nominal thickness and thicker shall be measured on the same basis as on wide faces.

Local deviations must be considered in small sizes, and if a local deviation occurs in a piece less than 4" nominal

in width or on the narrow face of a piece less than 2" nominal in thickness, and is not associated with a permissible knot in the piece, the measurement of slope shall include the local deviation.

1.16 SPLITS

Are measured by average penetration. One maximum allowable split is permitted on each end of the piece. When more than one split occurs, only the worst split is considered for length of split.

1.17 UNSOUND WOOD

Note: "Heart Center Streaks" is a localized decay peculiar to Southern Pine and the limitation applies to that species.

Note: "Peck" is a type of decay peculiar to species of cedar and applies to those species.

Note: "Honeycomb" is found in most softwood species and is similar to "white speck" except the pitted areas are more elongated or channeled.

Note: "Firm" in relation to white speck and honeycomb provisions infers that it will not crumble readily under thumb pressure and cannot be easily picked out.

In **No. 2** and **Standard**, white speck "1/3 face or equivalent" is a volume restriction. When white speck appears, it is limited to the following or equivalent area: **a)** a maximum of 1/3 the length for the full width of the face, or **b)** a maximum of 1/3 the width of the face for the full length.

In **No. 2** and **Standard**, firm honeycomb or peck on the narrow face that occupies the entire thickness shall not penetrate more than 1/6 the width of the wide face and such peck must not destroy the nailing edge.

In **No. 3**, **Utility** and **Stud**, "spots or streaks" of soft decay occurring on one face shall **not** be limited in length; if through two faces; each streak is limited to 1/6 the length of the piece. Measurement shall be taken in the through portion of the streak.

1.18 WANE

In reference to paragraph 750, wane is permitted to extend partially or completely through the narrow face provided it does not displace more area than the allowable hole and does not exceed in length more than twice the allowable hole diameter. Wane is permitted to extend partially or completely across any face provided it does not exceed the depth of the specified skip nor exceed one foot in length. Such wane permitted in the grade description shall be measured at the point that wane exceeds the maximum thickness or width provision as stated in the grade. Wane extending partially or completely across any face shall be included in the assessment of equivalent wane. "Away from ends" means such wane shall not appear on the end section of the piece.

WANE EXAMPLES - THICKNESS - No. 2/Standard Grades

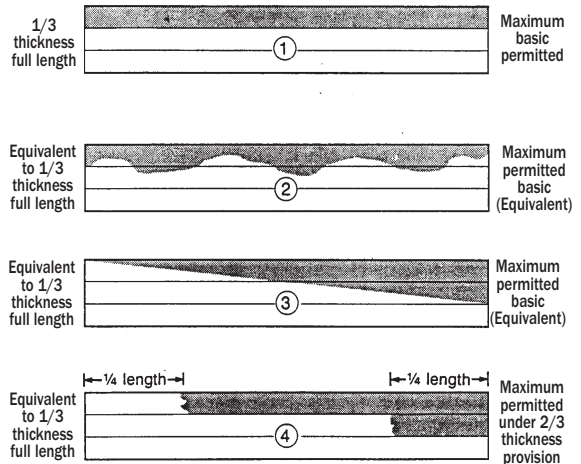

- 1) Basic
- 2) Equivalent to basic
- 3) Equivalent to basic
- 4) Equivalent to basic. Maximum amount of incremental wane permitted

Basic wane is maximum full length wane as stated in the NGR. The same concept of equivalent wane in thickness and width applies to all grades within their respective stated limitations.

1.19 WARP

Measurement of Crook, Twist and Bow When in Combination. When two or more forms of warp are present in the same piece, only proportionate amounts of each are permitted. Maximum warp is based on a gradual deviation from one end of the piece to the other. Bow is limited according to thickness, not width. Other forms of warp are limited according to width.